

CODA

C O D A A U D I O

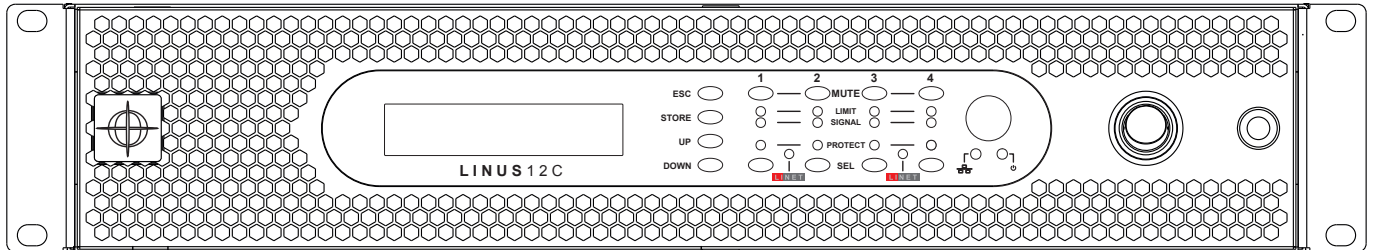

LINUS12C



INFORMATION FOR USE FOR MODELS CODA AUDIO LINUS12C

The leading version of this brochure is the English one which shall prevail to the exclusion of the national translation on hand.

USER MANUAL v1.2

CODA

C O D A A U D I O





LINUS12C CONTACT

Manufacturer

Address: **CODA Audio GmbH
Boulevard der EU 6
D - 30539 Hannover
Germany**

Telephone: **+49 (0) 511 866 55 888**
Fax: **+49 (0) 511 866 55 887**
Internet: **www.codaaudio.com**
Email: **contact@codaaudio.com**

Subject to change. Please visit our website www.codaaudio.com for the latest version of this User Manual.
Please note that the leading version of CODA Audio manuals is always the English one.

IMPORTANT SAFETY INSTRUCTIONS	4
SYMBOLS	6
CE CONFORMITY	7
CONSIGNES DE SÉCURITÉ IMPORTANTES	8
SYMBOLES	10
CE CONFORMITÉ	11
WICHTIGE SICHERHEITSHINWEISE	12
SYMBOLE	14
EU-KONFORMITÄTSERKLÄRUNG	15
1. WELCOME TO CODA AUDIO	16
2. THE AMPLIFIER	17
2.1 Unpacking	17
2.2 The amplifier	17
3. INSTALLATION	19
3.1 Mounting	19
3.2 Cooling	20
3.3. Mains	20
3.4 Signal inputs	22
3.5 Remote control inputs (Ethernet)	23
3.6 Power outputs	23
4. OPERATION	24
4.1 Screen user interface	24
4.2 Power amp protection systems	28
4.3 Mains protection	28
4.4 Main SMPS protection	28
4.5 Fans	28
5. SPECIFICATION	29
6. PERFORMANCE	33
7. WARRANTY	35
7.1 Warranty	35
7.2 Items excluded from this warranty	35
7.3 What CODA Audio will do	35
7.4 How to obtain warranty service	35
7.5 CODA Audio's product improvement	35
7.6 Warranty form	36
8. MAINTENANCE INFORMATION	37
9. DECOMMISSIONING	37
10. WHAT'S IN THE BOX	37
11. NOTES - CHANGES MADE TO THE AMPLIFIER	38

IMPORTANT SAFETY INSTRUCTIONS

1. General

The amplifier may only be used in accordance with the information provided in the user manual. Before and during the usage of the amplifier please ensure that all recommendations, especially the safety recommendations as detailed in the user manual, are adhered to. The CODA Audio LINUS amplifier is designed for the amplification of pulsed audio signals. The amplifier should only be connected to loudspeakers with an average impedance as indicated.

2. User manual

Read the information before use (user manual) and heed all warnings. During the lifetime of the amplifier keep this user manual together with the warranty certificate in a safe place for later reference. The user manual forms an integral part of the amplifier. It is recommended to check the CODA Audio website for any updates and new versions of this manual. Reselling the amplifier is only possible if the user manual is available. In case of reselling the amplifier, the reseller has to document any changes made to the amplifier in writing and pass the documentation on to the buyer.

3. Environments

Use this amplifier only in E1, E2, E3, E4 or E5 environments according to IEC/EN 55103-2:2010 "Electromagnetic compatibility - Product family standard for audio, video, and audio-visual and entertainment lighting control apparatus for professional use - Part 2: Immunity".

4. Mounting/placement

Do not place this amplifier on an unstable cart, stand, tripod, bracket, or table. The amplifier may fall, causing serious injury and serious damage to the product. Any mounting of the amplifier should follow the manufacturer's instructions. CODA Audio can recommend suitable mounting racks and accessories.

5. Mains connection

The amplifier may only be connected to a socket with a protective earth conductor. This is a class 1 device that requires an external earth connection at all times. A missing earth may cause unexpected and high voltages present on the metal casing and surrounding conductors. The main power switch on the front panel is a 'soft' switch. Ensure that the mains power can be isolated from the amplifier at any time.

6. Power cord protection

Power supply cords should be routed so that they are not likely to be walked on or pinched by items placed upon them or against them, paying particular attention to cords and plugs and the point where they exit from the amplifier. If the cord is damaged in any way obtain a replacement cord before further use.

7. Heat

Do not use this amplifier near any heat sources such as radiators, heaters, stoves, or other apparatus that produce heat.

8. Water and moisture

Do not expose this device to rain or moisture. Do not use this amplifier near water (for example swimming pools and fountains). Do not place any objects containing liquids, such as bottles or glasses, on the top of the unit. Do not splash liquids on the unit. There is no protection against splashing water (IP-20 equipment).

9. Ventilation

Slots and openings in the cabinet are provided for ventilation to ensure reliable operation of the amplifier and to protect it from overheating. These openings must not be blocked or covered. This amplifier should not be installed unless proper ventilation is provided, and the following instructions are adhered to. When installing into racks, careful consideration should be taken to ensure that the force air cooling operates to its maximum efficiency. Cold air is drawn in through the front of the unit, with the hot air expelled from the rear. Ensure that the rear is not obstructed to allow the heat to escape. Do not install the amplifier above or below any other equipment that has a different forced air flow cooling design. If a space is to be left between multiple units then a fixed rack space blank should be used. A vented or slotted space should not be used as this can significantly reduced the efficiency of the forced air cooling of the unit.

10. Interference of external objects and/or liquids with the appliance

Never push objects of any kind into this amplifier through any openings, as they may touch dangerous voltage points or

short out parts that could result in fire or electric shock. Never spill liquid of any kind on the amplifier. Do not use the amplifier in a place where is the potential risk of objects/liquids falling onto or into the amplifier. Where possible, the amplifier should always be used within a protective case or rack.

11. Connections

Before connecting external equipment to the amplifier, ensure that it is safe to do so. Remove the mains supply from the equipment where necessary. Failure to do so may cause an electric shock and serious personal injury. Read the user manual of the other equipment carefully and follow the instructions when making the connections.

12. Lightning

For additional protection of this amplifier during lightning storms or when it is left unattended and/or unused for long periods of time, unplug it from the wall outlet. This will prevent damage to the amplifier due to lightning and power line surges. Disconnection from the mains power supply can only be achieved by removing the plug from the mains socket or by external disconnecting all poles from the mains.

13. Damages that require service

Unplug this amplifier from the mains supply and refer to your dealer/distributor or other authorized repair workshop if any of the following situations occur:

- if liquid has been spilled or objects have fallen into the amplifier,
- if the amplifier has been exposed to rain or moisture,
- if the amplifier has been dropped or damaged in any way,
- if the power supply cord or plug has been damaged,
- when the amplifier exhibits a distinct change from its normal function or performance,
- in case the amplifier has been used in a dusty environment for quite a period of time.

14. Servicing

All service and repair work must be carried out by a dealer/distributor authorized by CODA Audio. Do not attempt to service this amplifier yourself. Opening or removing covers may expose you to dangers or other hazards. The amplifier may only be opened by qualified personnel. Please refer to your dealer/distributor.

15. Spare parts

When spare parts are required, the dealer/distributor will only use spare parts specified by the manufacturer. The use of unauthorized spare parts may result in injury and/or damage through fire or electric shock or other electricity-related hazards.

16. Safety check

Upon completion of any service or repairs to this product, other than by the factory, ask the dealer/distributor to perform safety checks to determine that the amplifier works properly. Recommendations on how to carry out the safety test can be found in DIN VDE 0701-0702 "Maintenance, Modification and Test of Electronic Appliances".

17. Cleaning

Ensure that periodic cleaning of the dust filters is carried out to maintain the best possible cooling. Monitor the environment that the amplifier is operating in and adjust the cleaning frequency as necessary. Unplug this amplifier from the wall outlet before cleaning. Do not use liquid or aerosol cleaners. Clean only with dry cloth. For more details refer to chapter 8 "Maintenance Information" (p. 37).

18. Packaging and shipping

When shipping the CODA Audio LINUS amplifier, always use the original shipping carton and packing materials. For maximum protection repack the unit as it was originally packed at the factory.

19. Altitude (for China)

The amplifier shall be operated at altitudes below or equal 2000 m.





LINUS12C SYMBOLS



CAUTION

RISK OF ELECTRIC SHOCK
DO NOT OPEN



CAUTION - HIGH VOLTAGE HAZARDS
EXIST WITHIN THIS PRODUCT.
REFER ALL SERVICING TO
AUTHORIZED PERSONNEL



THE LIGHTNING FLASH WITH ARROW HEAD SYMBOL IS INTENDED
TO ALERT THE USER TO THE PRESENCE OF UNINSULATED DANGEROUS
VOLTAGE WITHIN THE PRODUCT'S ENCLOSURE.



THE EXCLAMATION MARK IS INTENDED TO ALERT THE USER
TO IMPORTANT INSTRUCTIONS ALSO FOR MAINTENANCE
IN THE LITERATURE ACCOMPANYING THE AMPLIFIER.



WARNING - TO PREVENT FIRE OR SHOCK HAZARD,
DO NOT EXPOSE THIS AMPLIFIER TO RAIN OR MOISTURE.



CAUTION - RISK OF ELECTRIC SHOCK- DO NOT OPEN.



THE AMPLIFIER SHALL ONLY BE OPERATED
AT ALTITUDES BELOW OR EQUAL 2000 m.



THE AMPLIFIER MAY ONLY BE CONNECTED
TO A SOCKET WITH A PROTECTIVE EARTH CONDUCTOR.

LINUS12C CE CONFORMITY

CE CONFORMITY

Declaration of conformity in accordance to EC Directives:

Electromagnetic compatibility (Council Directive 2014/30/EU, EMC)
Low-voltage electrical equipment (Council Directive 2014/35/EU, LVD)
2011/65/EU (RoHS2 Directive)

Manufacturer's name: **CODA Audio GmbH**
Manufacturer's address: **Boulevard der EU 6, 30539 Hannover, Germany**

declares that the product with the model name: **LINUS12C** conforms to the following standards:

IEC/EN/UL/CSA 62368-1:2016 Safety
IEC/EN 55103-1:2010 Emission (for all environments E1/residential to ES/industrial)
IEC/EN 55103-2:2010 Immunity (for all environments E1/residential to ES/industrial)

The operating conditions and application environments presupposed in the information for use (user manual) are to be kept accordingly.

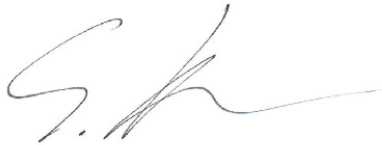

Svetlomir Aleksandrov
EC DECLARATION OF CONFORMITY
Hannover, 01.10.2021



At the end of its life, this product may not be disposed of in the normal waste, but rather must be disposed of at a collection point for recycling electrical and electronic devices. The materials are recyclable according to their labelling. You make an important contribution to protecting our environment by reusing, recycling or utilising old devices in other ways. Please ask the municipal administration where the appropriate disposal facility is located.



CONSIGNES DE SÉCURITÉ IMPORTANTES

1. Général

L'amplificateur ne doit être utilisé qu'en conformité avec les informations indiquées dans le manuel d'utilisation. Avant et pendant l'utilisation de l'amplificateur, s'assurer que toutes les consignes, surtout les consignes de sécurité décrites dans le mode d'emploi sont respectées. L'amplificateur LINUS a été construit pour l'amplification de signaux audio pulsés et ne doit être branché qu'à des enceintes ayant une impédance moyenne comme celle indiquée.

2. Mode d'emploi

Lisez les instructions d'utilisation (Manuel Utilisateur) et prêtez attention à tous les avertissements. Conserver ce mode d'emploi dans un endroit protégé durant toute la vie d'utilisation de l'amplificateur. Ce mode d'emploi fait partie intégrante de l'amplificateur. Il est recommandé de visiter régulièrement le site web de CODA Audio afin d'obtenir les mises à jour et nouvelles versions de ce manuel. La revente de l'amplificateur n'est possible qu'avec le mode d'emploi. Tout changement subi par l'amplificateur doit être documenté par écrit et transmis à l'acheteur dans le cas d'une revente.

3. Environnement

N'utilisez l'amplificateur que dans les environnements classés E1, E2, E3, E4 ou E5 selon la norme IEC/EN 55103-2 : 2010 « Compatibilité électromagnétique - Norme de famille de produits pour les appareils à usage professionnel audio, vidéo, audiovisuels et de commande de lumière pour spectacles. Immunité Norme de famille de produits pour les appareils à usage professionnel audio, vidéo, audiovisuels et de commande de lumière pour spectacles - Partie 2 : Immunité ».

4. Installation/emplacement

Ne pas placer l'amplificateur sur un chariot, un stand, un trépied, un support ou une table instable. Le produit pourrait chuter, s'endommager sérieusement et provoquer de graves blessures. Pour l'installation de l'amplificateur, observez les instructions du fabricant et utilisez les accessoires recommandés par le fabricant.

5. Connection secteur

Branchez l'amplificateur uniquement à une prise électrique avec une connexion à la terre. Ceci est un appareil de Classe 1 qui nécessite une connexion électrique avec prise de terre lors de chaque utilisation. Un défaut de terre peut être à l'origine de hautes tensions présentes sur le châssis métallique. L'interrupteur électrique étant un modèle 'soft', assurez-vous de la bonne isolation de l'amplificateur par rapport à l'alimentation électrique.

6. Protection du cordon d'alimentation

Les câbles d'alimentation électriques sont à disposer de manière à ne pas être piétinés ou coincés par des objets placés au-dessus ou contre eux-mêmes, tout en faisant attention aux câbles et aux fiches et particulièrement au connecteur de sortie de l'amplificateur. Le dispositif de déconnexion du secteur (le câble et connecteur secteur ou le disjoncteur thermique) doit être accessible à tout instant. Si le cordon d'alimentation est endommagé, prenez soin d'en changer avant chaque nouvelle utilisation.

7. Chaleur

Ne pas utiliser l'amplificateur près de sources de chaleur comme les radiateurs, les corps chauffants, les fourneaux ou d'autres dispositifs qui produisent de la chaleur.

8. Eau et humidité

Ne pas exposer le Produit à la pluie ou à l'humidité, ne pas utiliser le Produit à proximité d'eau et ne pas utiliser le Produit s'il est mouillé (par exemple dans des pièces humides ou près d'une piscine). Ne placez jamais des objets contenant des liquides sur le produit (comme par exemple des bouteilles ou des verres). Ne versez pas de liquides sur le Produit. Il s'agit d'un produit IP20 sans protection contre les éclaboussures.

9. Ventilation

Les grilles et les ouvertures dans le boîtier servent à la ventilation et assurent un bon fonctionnement de l'amplificateur tout en le protégeant de la surchauffe. Ces ouvertures ne doivent être ni bloquées ni couvertes. L'amplificateur ne doit être installé que dans un endroit convenablement ventilé et aéré, selon les recommandations du fabricant données dans ce manuel. Lors d'une installation en Rack, assurez-vous d'une aération maximum afin de permettre le refroidissement de l'appareil. L'air froid rentre par l'avant de l'appareil alors que l'air chaud sortira par l'arrière. Assurez-vous que l'arrière de l'appareil n'est pas obstrué afin de permettre une bonne extraction de la chaleur. N'installez pas l'amplificateur ni au dessus ni au dessous d'un appareil n'ayant pas le même système de refroidissement. Si un espace doit-être laissé entre plusieurs appareils alors vous devrez ajouter des faces avant dans les Racks afin de combler ces vides. Aucun ventilateur ni système spécial ne devra être utilisé car ils pourraient réduire le refroidissement naturel de l'appareil.

10. Intrusion d'objets externes et / ou liquides dans l'amplificateur

Ne jamais introduire d'objets d'aucune sorte dans l'amplificateur au travers des ouvertures car ils pourraient être en contact avec des tensions électriques dangereuses ou provoquer un court-circuit de composants et ainsi un feu ou un choc électrique. Ne jamais renverser de liquide sur l'amplificateur. N'utilisez pas l'amplificateur dans un lieu où des objets, du liquide pourrait couler sur ou dans l'amplificateur.

11. Branchements

Avant de connecter des équipements externes à l'amplificateur, assurez-vous de pouvoir le faire en toute sécurité. Débranchez l'alimentation électrique des équipements externes si besoin. Faute de quoi il y a un risque de choc électrique et de lésions sérieuses. Lisez attentivement le mode d'emploi des autres dispositifs et suivez les instructions des autres équipements lors de tous branchements.

12. Foudre

Pour une protection renforcée de l'amplificateur, le débrancher de la prise secteur pendant les orages ou quand il est sans surveillance et / ou non utilisé pendant un temps prolongé. Ainsi, vous éviterez un endommagement de l'amplificateur dû à la foudre et aux surtensions. La déconnexion du secteur n'est possible qu'en retirant la prise de l'alimentation générale ou en débranchant tous les contacts du réseau électrique.

13. Dommages nécessitant une intervention

Dans les cas suivants, débranchez l'amplificateur du réseau électrique et contactez votre revendeur / distributeur ou un atelier autorisé :

- du liquide a été renversé ou des objets sont tombés dans l'amplificateur
- l'amplificateur a été exposé à la pluie ou à l'humidité
- l'amplificateur est tombé ou a été abimé de quelque façon que ce soit
- le cordon d'alimentation ou la fiche électrique est endommagé
- l'amplificateur ne fonctionne pas de manière normale comme décrit dans le mode d'emploi
- l'amplificateur a été utilisé dans un environnement poussiéreux pendant un temps prolongé

14. Entretien

Toute opération de maintenance ou réparation doit être effectuée par un revendeur / distributeur certifié par CODA Audio. N'essayez pas d'entretenir l'amplificateur par vous-même. L'ouverture de l'amplificateur ou retirer le capot pourrait vous exposer à une tension électrique dangereuse ou à d'autres risques, l'amplificateur ne doit être ouvert que par du personnel qualifié. Veuillez contacter votre revendeur / distributeur.

15. Réparation et pièces de rechange

Si des pièces de rechange sont nécessaire, assurez-vous que votre revendeur / distributeur n'utilise que des pièces de rechange certifiées par le constructeur. L'utilisation de pièces de rechange non autorisées peut causer des lésions et / ou des endommagements par le feu, choc électrique, ou d'autres dangers d'origine électrique.

16. Contrôle de sécurité

Après un entretien ou une réparation du produit fait en dehors de l'Usine, demander au revendeur / distributeur de faire des contrôles de sécurité pour s'assurer que l'amplificateur est en parfait état de fonctionnement. Des conseils pour les contrôles de sécurité se trouvent dans la norme DIN VDE 0701-0702, « Entretien, modifications et test des appareils électriques ».

17. Nettoyage

Assurez-vous de nettoyer périodiquement les filtres à poussière en face avant afin d'assurer un refroidissement optimal de l'appareil. Surveillez l'environnement dans lequel l'amplificateur fonctionne et ajuster les fréquences de nettoyage des filtres en conséquence. Débrancher l'amplificateur de la prise électrique avant de le nettoyer. Ne pas utiliser de produits liquides ou vaporisés. Nettoyez uniquement avec des linges secs. Voir également 8. Maintenance Information, p. 37.

18. Emballage et expédition



Pour expédier l'amplificateur LINUS veuillez toujours utiliser le carton et l'emballage d'origine. Pour une protection maximale, toujours emballer l'unité comme elle l'a été à sa sortie d'usine.

19. Altitude (pour la Chine)

L'amplificateur ne doit pas être utilisé à des altitudes dépassant 2000 m.



SYMBOLES

	ATTENTION RISQUE DE CHOC ÉLECTRIQUE NE PAS OUVRIR		ATTENTION —CE PRODUIT PRÉSENTE DES RISQUES ASSOCIÉS AU COURANT ÉLEVÉ. TOUT SERVICE DOIT ÊTRE EFFECTUÉ PAR DU PERSONNEL AUTORISÉ.
---	--	---	--

	L'ÉCLAIR AVEC LE SYMBOLE DE LA FLÉCHE SERT À AVERTIR L'UTILISATEUR DE LA PRÉSENCE D'UNE TENSION NON ISOLÉE À L'INTÉRIEUR DE LA CAISSE.
---	--

	LE POINT D'EXCLAMATION SERT ÉGALEMENT À AVERTIR L'UTILISATEUR D'INSTRUCTIONS IMPORTANTES POUR L'ENTRETIEN CONTENUES DANS LA DOCUMENTATION DE L'AMPLIFICATEUR.
---	---

	AVERTISSEMENT —POUR ÉVITER DU FEU OU DES CHOC ÉLECTRIQUES, NE PAS EXPOSER CET AMPLIFICATEUR À LA PLUIE OU À L'HUMIDITÉ.
---	---

	ATTENTION —RISQUE DE CHOC ÉLECTRIQUE —NE PAS OUVRIR.
---	--

	L'AMPLIFICATEUR NE DOIT PAS ÊTRE UTILISÉ À DES ALTITUDES DÉPASSANT 2000 m.
---	---

	NE BRANCHER CET AMPLIFICATEUR UNIQUEMENT À UNE PRISE RELIÉE À LA TERRE.
---	--

CE CONFORMITÉ

Déclaration de conformité CE selon les directives CE :

Compatibilité électromagnétique (Directive 2014/30/EU Conseil Européen, EMC)
Basse tension (Directive 2014/35/EU du Conseil Européen, LVD)
2011/65/EU (RoHS2)

Nom du constructeur : **CODA Audio GmbH**
Adresse du constructeur : **Boulevard der EU 6, 30539 Hannover, Allemagne**

déclare que le produit avec le nom de modèle : Amplificateur **LINUS12C** est en conformité avec les normes suivantes :

IEC/EN/UL/CSA 62368-1 : 2016 Sécurité

IEC/EN 55103-1 : 2010 Emission (pour tous les environnements E1 / résidentiel à E5 / industriel)

IEC/EN 55103-2 : 2010 Immunité (pour tous les environnements E1 / résidentiel a E5 / industriel)

Les conditions d'utilisation ainsi que les environnements d'exploitation décrits dans le mode d'emploi sont à respecter scrupuleusement.



Svetlomid Aleksandrov

EC DECLARATION OF CONFORMITY

Hannover, 01.10.2021



Au terme de son utilisation ce produit ne doit pas être éliminé avec les déchets ménagers habituels, mais il doit être déposé dans un point de collecte pour le recyclage d'appareils électriques et électroniques.

Les matériaux sont recyclables conformément à leur identification. Grâce à la réutilisation, le recyclage de matériaux ou d'autres formes de recyclage de vieux appareils vous contribuez de manière significative à la protection de notre environnement.

Veuillez contacter votre municipalité pour connaître le centre de traitement compétent.



WICHTIGE SICHERHEITSHINWEISE

1. Allgemeines

Der Verstärker darf nur in Übereinstimmung mit den Anweisungen und Informationen in dieser Anleitung genutzt werden. Stellen Sie vor und während der Nutzung des Verstärkers sicher, dass allen Anweisungen, insbesondere den Sicherheitsanweisungen Folge geleistet wird. Die CODA Audio LINUS Verstärker sind darauf ausgelegt ein gepulstes Audiosignal zu verarbeiten und zu verstärken. An den Verstärker dürfen ausschließlich Lautsprecher mit den in dieser Anleitung spezifizierten Impedanzen angeschlossen werden.

2. Anleitung

Lesen Sie die Anleitung vor der Benutzung des Verstärkers sorgfältig und beachten Sie alle Warnungen und Sicherheitshinweise. Bewahren Sie diese Bedienungsanleitung zusammen mit dem Garantieschein zum späteren Nachschlagen an einem sicheren Ort auf. Diese stellt einen integralen Bestandteil des Verstärkers dar. Wir empfehlen die CODA Audio Webseite regelmäßig nach Updates und/oder neuen Versionen der Anleitung zu prüfen. Der Wiederverkauf des Verstärkers ist nur möglich, wenn die Benutzeranleitung vorhanden ist. Im Falle des Wiederverkaufs ist der Wiederverkäufer verpflichtet alle Änderungen, die er am Verstärker vorgenommen hat, zu dokumentieren und dem Käufer zur Verfügung zu stellen.

3. Einsatzumgebung

Benutzen Sie den Verstärker nur in E1, E2, E3, E4 oder E5 Umgebungen gemäß IEC/EN 55103-2:2010 „Elektromagnetische Verträglichkeit - Produktfamilienorm für Audio-, Video- und audiovisuelle Einrichtungen sowie für Studio-Lichtsteuereinrichtungen für professionellen Einsatz - Teil 2: Störfestigkeit“.

4. Montage/Aufstellung

Platzieren Sie den Verstärker nicht auf einem unstabilen Wagen, Ständer, Dreibein, Rahmen oder Tisch. Dies kann zu ernsthaften Verletzungen von Personen und/oder Beschädigungen des Verstärkers führen. Jegliche Montage darf nur gemäß der Anleitung des Herstellers erfolgen. Es ist nur Montagezubehör zu verwenden, welches vom Hersteller freigegeben wurde.

5. Netzanschluss

Der Verstärker darf nur an Anschlüsse mit einem dedizierten Erdungsleiter angeschlossen werden. Bei dem Verstärker handelt es sich um ein Gerät der Gerätekategorie 1, welches zu jeder Zeit geerdet sein muss. Fehlende Erdung kann unerwartete und hohe Spannungen am Gehäuse und den umliegenden Leitungen verursachen. Da es sich beim Hauptschalter auf der Vorderseite des Gerätes um einen Soft-Switch handelt, muss sichergestellt werden, dass der Verstärker jederzeit vollständig von der Stromquelle getrennt/isoliert werden kann.

6. Netzkabelschutz

Das Netzkabel muss immer so verlegt werden, dass es nicht eingeklemmt, geknickt, überfahren, überlaufen, oder beschädigt werden kann. Dabei ist insbesondere auf die verstärkerseitigen Anschlüsse der Kabel zu achten, da es hier ansonsten auch zu Beschädigungen des Verstärkers kommen kann. Falls Kabel in jedweder Weise beschädigt sind, sorgen Sie für entsprechenden Ersatz vor der weiteren Verwendung.

7. Umgebungstemperatur

Setzen Sie den Verstärker nicht in der Nähe von Hitzequellen wie Heizungen, Heizlüftern, Thermen, Herden oder anderen Wärmequellen ein.

8. Wasser und Feuchtigkeit

Setzen Sie den Verstärker nicht Regen oder Feuchtigkeit aus. Setzen Sie den Verstärker nicht in der Nähe von Wasser (z.B. Schwimmbecken, Brunnen) ein. Stellen Sie keine Gegenstände auf dem Verstärker ab, die Flüssigkeit enthalten (z.B. Gläser, Tassen, Flaschen). Schützen Sie den Verstärker gegen Spritzwasser. Es handelt sich hierbei um IP20 Equipment.

9. Belüftung

Die Schächte und Öffnungen am Kabinett sind für die Ventilation vorgesehen, um einen verlässlichen Betrieb des Verstärkers zu gewährleisten und diesen vor Überhitzung zu schützen. Diese Öffnungen dürfen nicht blockiert oder verdeckt werden. Der Verstärker darf nicht installiert werden sofern keine ausreichende Belüftung sichergestellt ist. Bei der Installation in einem Gehäuse ist dafür Sorge zu tragen, dass ein ungehinderter Luftstrom zur Sicherstellung der maximalen Kühlleistung, gewährleistet ist. Kalte Luft wird durch den vorderen Teil des Gerätes eingeblasen und die heiße Luft an der Rückseite des Gerätes wieder ausgestoßen. Stellen Sie sicher, dass die Rückseite nicht blockiert ist und die heiße Luft daran hindert zu entweichen. Es ist untersagt den Verstärker ober- oder unterhalb eines

Gerätes zu installieren, welches ein anderes Luftstromdesign hat. Wenn mehrere Geräte zusammen in einem Rack montiert werden, muss zwischen den einzelnen Geräten ein Platzhalter fest installiert werden. Dieser Platzhalter darf weder luftdurchlässig noch mit Luftschlitzen versehen sein, da dies signifikant die Leistungsfähigkeit des Luftstroms verringert.

10. Störung durch externe Objekte und/oder Flüssigkeiten

Versuchen Sie niemals Objekte jedweder Art durch die Öffnungen in den Verstärker zu bekommen. Dies kann zu Kontakt mit spannungsführenden Elementen führen, was einen Brand und/oder elektrischen Schlag verursachen kann. Verschütten Sie niemals Flüssigkeiten jedweder Art auf das Gerät. Verwenden Sie den Verstärker nicht in einer Umgebung, in der potentiell Gegenstände und/oder Flüssigkeit auf und/oder in den Verstärker gelangen könnten. Der Verstärker sollte möglichst in einem schützenden Gehäuse und/oder Rack verwendet werden.

11. Verbindung

Bevor Sie externes Equipment an den Verstärker anschließen, prüfen Sie, ob es sicher ist, dies zu tun. Trennen Sie das Equipment von der Stromversorgung, wenn notwendig. Zuwiderhandlungen können zu einem Stromschlag und ernsthaften Verletzungen führen. Lesen Sie Bedienungsanleitung des anzuschließenden Gerätes sorgfältig bevor Sie die Verbindung herstellen.

12. Blitzschlag

Trennen Sie den Verstärker vom Netz für zusätzlichen Schutz des Verstärkers während eines Gewitters oder wenn dieser für längere Zeit nicht benutzt/beaufsichtigt wird. Dies verhindert eine Beschädigung des Verstärkers durch Blitzeinschlag und/oder Netzschwankungen. Eine vollständige Trennung des Verstärkers vom Stromnetz erfolgt nur durch Abziehen des Netzsteckers.

13. Schäden die Serviceleistungen erfordern

Trennen Sie den Verstärker vom Stromnetz und kontaktieren Sie Ihren Händler/Distributor oder ein autorisiertes Service Center wenn eine der folgenden Situationen eingetreten ist:

- Flüssigkeit wurde auf den Verstärker verschüttet,
- Fremdkörper sind in den Verstärker gelangt,
- der Verstärker war Regen oder Feuchtigkeit ausgesetzt,
- der Verstärker wurde mechanisch beschädigt,
- das Netzkabel/der Netzstecker sind beschädigt,
- der Verstärker zeigt ein abnormales Verhalten im Betrieb,
- der Verstärker wurde längere Zeit in einer staubigen Umgebung eingesetzt.

14. Service

Jegliche Reparaturarbeiten müssen durch eine von CODA Audio autorisierte Stelle durchgeführt werden. Versuchen Sie nicht den Verstärker selbst zu reparieren, da das Öffnen des Verstärkers Sie gefährlichen Spannungen und anderen Risiken aussetzen kann. Der Verstärker darf nur von qualifiziertem und autorisiertem Personal geöffnet werden. Bitte wenden Sie sich an Ihren Händler.

15. Ersatzteile

Sofern Ersatzteile benötigt werden stellen Sie bitte sicher, dass Ihr Händler nur vom Hersteller freigegebenen Ersatzteile benutzt. Die Nutzung von nicht freigegebenen Ersatzteilen kann Verletzungen und/oder Schäden durch Feuer, Stromschlag oder andere verwandte elektrische Gefahren verursachen.

16. Sicherheitstest

Nach Beendigung von Servicearbeiten an dem Produkt ist es ratsam Sicherheitstests vom Hersteller oder einem von ihm autorisierten Servicepartner (z.B. Händler/Vertrieb) durchführen zu lassen, um sicher zu stellen, dass der Verstärker sachgemäß funktioniert. Empfehlungen zur Durchführung eines solchen Tests können der DIN VDE 0701-0702 „Instandsetzung, Änderung und Prüfung elektrischer Geräte“ entnommen werden.

17. Reinigung

Stellen Sie sicher, dass die Staubfilter regelmäßig gereinigt werden, um die bestmögliche Kühlung des Verstärkers aufrechtzuerhalten. Achten Sie auf die Betriebsumgebung des Verstärkers und stimmen Sie die Reinigung der Staubfilter dementsprechend ab. Trennen Sie den Verstärker vom Netz bevor Sie mit der Reinigung beginnen. Benutzen Sie nur einen trockenen Lappen und keine flüssigen Reiniger oder Aerosole. Vgl. dazu auch 8. Maintenance Information S. 37.

18. Verpackung und Versand

Nutzen Sie für den Versand des Verstärkers nur die originale Kartongabe. Für ein Maximum an Sicherheit soll der Verstärker vor dem Versand so verpackt werden, wie er ursprünglich vom Werk geliefert wurde.

19. Einsatzhöhe

Der Verstärker soll nur in Höhen bis 2000 m über Meeresspiegel eingesetzt werden.



SYMBOLE



VORSICHT

NICHT ÖFFNEN –
STROMSCHLAGGEFAHR.



VORSICHT: PRODUKT UNTER
HOCHSPANNUNG. ÜBERLASSEN SIE
JEDLICHE WARTUNGSARBEITEN
AUTORISIERTEM KUNDENDIENST.



DAS BLITZSYMBOL WARNT DEN BENUTZER VOR NICHTISOLIERTEN
GEFÄHRLICHEN SPANNUNGEN INNERHALB DES GEHÄUSES.



DAS AUSRUFEZEICHEN SOLL BENUTZER AUF WICHTIGE BETRIEBUNGS-
UND WARTUNGSANLEITUNGEN IN DER
DEM VERSTÄRKER BEIGEFÜGTEN LITERATUR AUFMERKSAM MACHEN.



WARNUNG: UM BRAND ODER STROMSCHLAG AUSZUSCHLIESSEN,
DARF DIESER VERSTÄRKER WEDER REGEN
NOCH FEUCHTIGKEIT AUSGESETZT WERDEN.



VORSICHT: NICHT ÖFFNEN – STROMSCHLAGGEFAHR.



DER VERSTÄRKER DARF NUR IN HÖHE BIS 2000 M EINGESETZT WERDEN.



DER VERSTÄRKER DARF NUR AN VERSORGUNGSNETZEN MIT
SCHUTZLEITER (ERDUNG) ANGESCHLOSSEN WERDEN.

EU-KONFORMITÄTSERKLÄRUNG

EU-Konformitätserklärung gemäß den EU-Richtlinien:

Elektromagnetische Verträglichkeit (EU-Richtlinie 2014/30/EU, EMC)
Elektrische Niederspannungsprodukte (EU-Richtlinie 2014/35/EU, LVD)
2011/65/EU (RoHS2-Richtlinie)

Name des Herstellers: **CODA Audio GmbH**
Adresse des Herstellers: **Boulevard der EU 6, 30539 Hannover, Deutschland**

erklärt, dass das Produkt mit der Modellbezeichnung: **LINUS12C** den folgenden Normen entspricht:

IEC/EN/UL/CSA 62368-1:2016 Sicherheitsnorm
IEC/EN 55103-1:2010 Emissionen (für alle Umgebungen E1/Wohngebiete bis ES/gewerblich)
IEC/EN 55103-2 :2010 Störfestigkeit (für alle Umgebungen E1/Wohngebiete bis ES/gewerblich)

Die in den Benutzerinformationen angegebenen Betriebsbedingungen sind entsprechend einzuhalten.



Svetlomid Aleksandrov
EU-Konformitätserklärung
Hannover, 01.10.2021



Dieses Produkt darf am Ende seiner Lebensdauer nicht über den normalen Abfall entsorgt werden, sondern muss an einem Sammelpunkt für das Recycling von elektrischen und elektronischen Geräten abgegeben werden.

Die Werkstoffe sind gemäß ihrer Kennzeichnung wiederverwertbar. Mit der Wiederverwendung, der stofflichen Verwertung oder anderen Formen der Verwertung von Altgeräten leisten Sie einen wichtigen Beitrag zum Schutz unserer Umwelt.

Bitte erfragen Sie bei der Gemeindeverwaltung die zuständige Entsorgungsstelle.



1. WELCOME TO CODA AUDIO

CODA Audio is a leading designer and manufacturer of high quality pro audio loudspeaker systems.

Core to our products are a number of unique patented driver technology designs which provide outstanding dynamic results as well as improved precision and reliability over conventional components.

To ensure the highest quality and control over our products, we have our own manufacturing facility in Europe which produces all of the driver and cabinet components. Further benefits to this approach include substantial reductions in cost and quicker times to market for new products.

We have a wide product range offering high quality solutions to satisfy the most discerning and complex professional sound reinforcement applications, ranging from portable to installation to touring.

CODA Audio is represented via a global network of experienced and technically qualified international distributors.

We believe that the best way to get to know us better is by listening to our loudspeakers because:

HEARING IS BELIEVING.

2. THE AMPLIFIER

2.1 Unpacking

Please unpack and inspect your new amplifier for any damage that may have occurred during transit. If damage is found, notify the transportation company immediately. Only you as the consignee may initiate a claim for shipping damage. CODA Audio will be happy to cooperate fully as needed. Please save the shipping carton as evidence of damage for the shipper's inspection.

Even if the amplifier has arrived in perfect condition, save all packing materials for any future transport of the unit. When shipping the LINUS12C amplifier, always use the original shipping carton and packing materials. For maximum protection, repack the unit as it was originally packed at the factory.

NOTE: Never ship the amplifier without the original packaging materials.

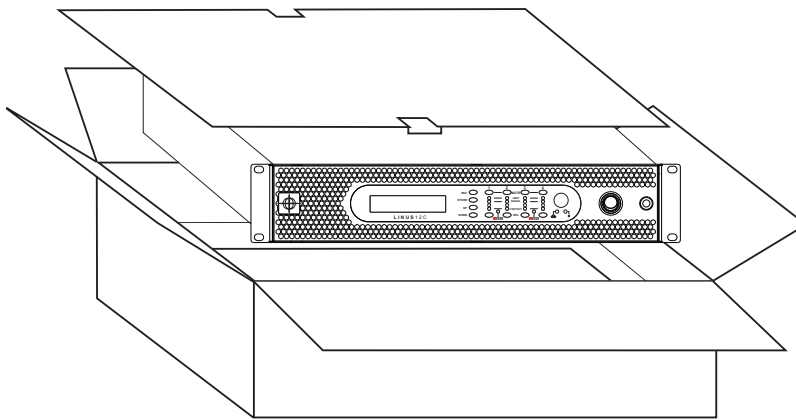

2.2 The amplifier

The LINUS12C amplifier offers a power output of:

- 6000 W peak per channel @ 4 Ω
- 5500 W peak per channel @ 2.7 Ω
- 4800 W peak per channel @ 2 Ω.

For a complete overview of rated power data please refer to chapter 5 `SPECIFICATION`.

The LINUS12C power amplifier is fitted with a dual voltage Switched Mode Power Supply (SMPS) with automatic voltage range selection for 115 V/230 V operation, which significantly reduces the weight and size (only 2U) of the amplifier. Using SMPS, the seamlessly regulated symmetrical supply voltages of the power amplifier are more stable and efficient than the power supplies used in conventional amplifiers.

The LINUS12C uses microprocessors for controlling and motoring the power amp. This has four main advantages over more traditional power amp systems:

1. Integrated remote control
2. Extreme fast and accurate monitoring of all amplifier parameters
3. Very fast triggering of protection features
4. Fast detection of failures.

The LINUS12C has been designed as an intelligent and powerful amplifier for performing specialised tasks within a complex audio system. Users can adapt the power amp to meet their specific audio requirements before use. The display mounted on the front of the LINUS12C amplifier allows the different functions to be accessed. Since there are a lot of parameters available, it is important that users familiarise themselves thoroughly with the entire range of settings and programmable features before using the power amp. If you have any questions regarding features and/or functions of your LINUS12C amplifier, CODA Audio will be pleased to provide you with further information. Alternatively, contact your dealer or distributor.

LINUS12C 2. THE AMPLIFIER

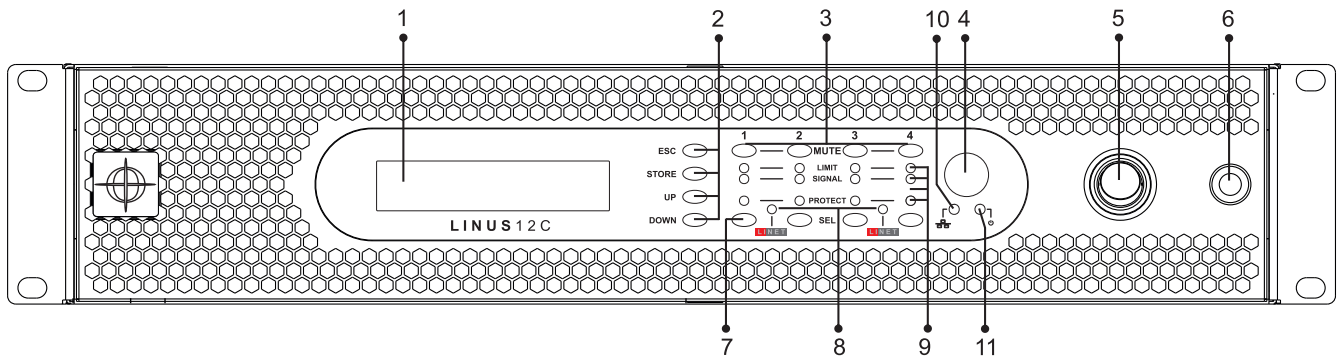

The front

- 1 Display
- 2 Navigation buttons
- 3 Channel mute buttons
- 4 Rotary encoder knob
- 5 1/0 Standby power switch
- 6 Grill screw
- 7 Channel selection buttons
- 8 LiNET LEDs
- 9 State LEDs
- 10 Ethernet connection LED
- 11 Mains connection LED
- 12 LINUS12C

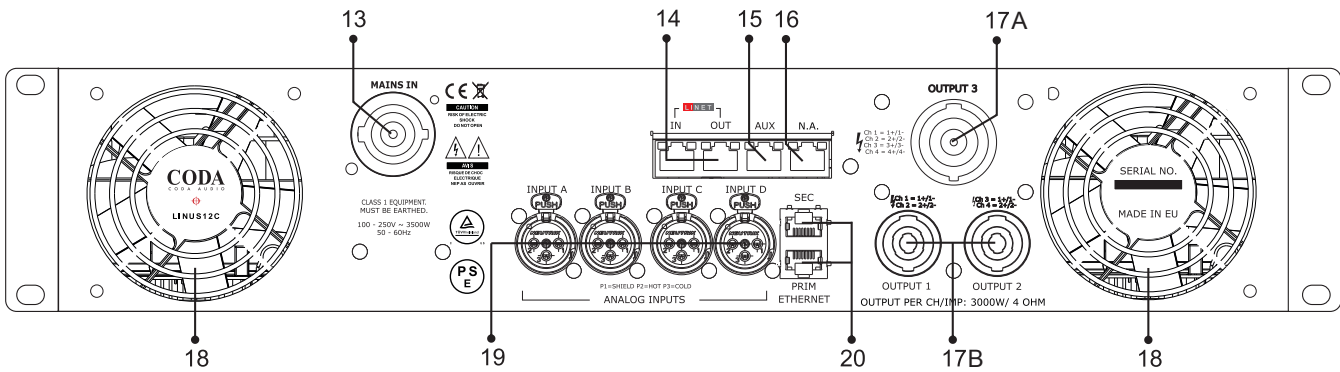

The rear

- 13 AC power connector (powerCON® 32 A)
- 14 LiNET network connections
1 IN/1 OUT (8 channels AES/EBU)
- 15 AUX connection (alarm override)
- 16 Connection not available
- 17 SPEAKON® amplifier output connectors:
17A NL8MP (4 channels)
17B NL4MP (2 channels each)
- 18 Cooling air outlet vents
- 19 XLR analog signal inputs
- 20 Ethernet connector for remote access

3. INSTALLATION

3.1 Mounting

Use four screws and washers when mounting the amplifier to the front rack rails. For mobile use, the amplifier should also be secured using the 19" mounting elements on the rear panel.

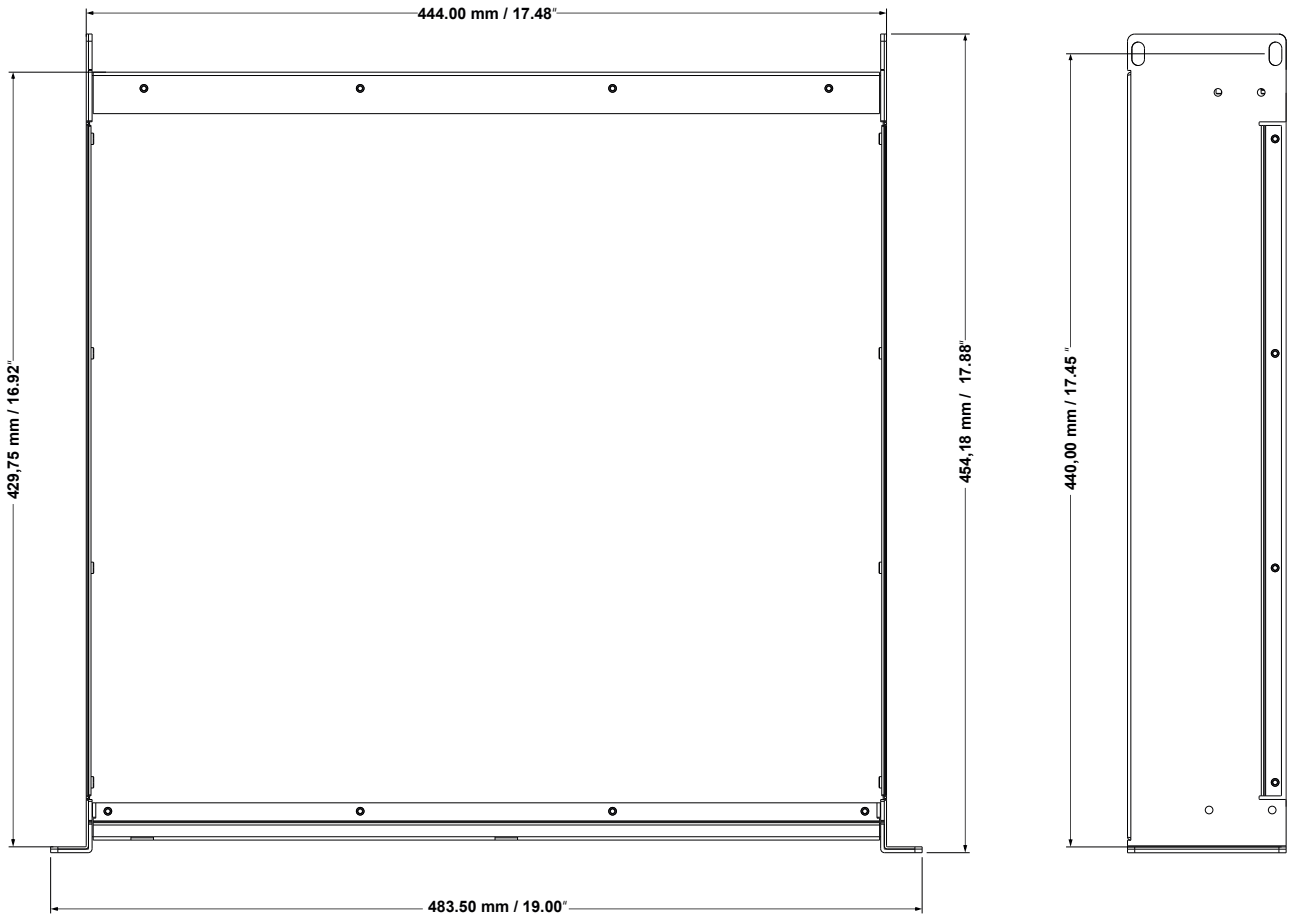
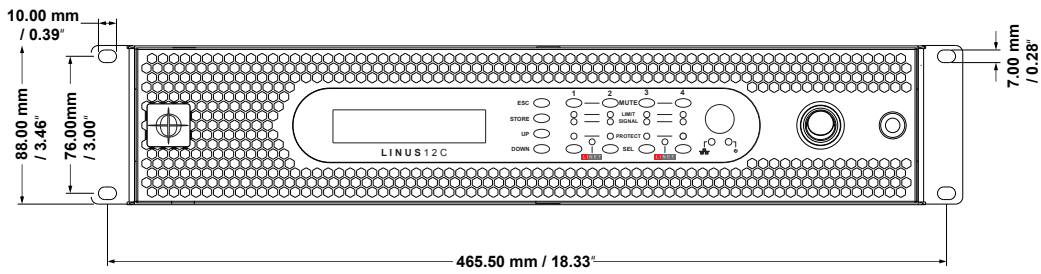

3.2 Cooling

Under normal operation of the power amp, overheating should never be a problem. The air is taken in from the front and out through the back. It is of course essential that, while the power amp is running, the air is able to circulate freely. The efficiency of the cooling will depend on both the immediate environment (e.g. an enclosed rack, direct sunlight) and if the front filter is clogged. If the amp is installed in a case, the open area at the back of the case must be at least 140 cm². This area should be in line with the amp. If this cannot be achieved, a forced ventilation system has to be used.

3.3. Mains

3.3.1 Mains supply

Only connect the LINUS12C amplifier to an appropriate AC circuit and outlet in accordance with the requirements indicated on the rating plate. Only use mains cables with original Neutrik powerCON® 32 A connectors for safety reasons.

CLASS 1 EQUIPMENT.
MUST BE EARTHED.
100 - 250V ~ 3500W
50 - 60Hz

The LINUS12C is shipped with an EU Style Schuko connector, which must be protected by a 16 A mains circuit breaker. US amplifier 120VAC ships with 2 meter NEMA L5-30P to powerCON® 32 A. It must be protected with a 30 A mains circuit breaker. For optimum amplifier output, larger circuit breakers may be used with alternative connectors, please contact CODA Technical Support for guidance.

Please do NOT use much larger mains breakers that recommended here and especially do NOT connect several LINUS12C amplifiers to one single (very large) breaker.

Always respect this rule of thumb for good installation practice for guaranteeing long term reliable, robust and safe operation: **one LINUS12C – one circuit breaker.**

As soon as the amplifier is connected to mains, the primary capacitors are charged through the inrush current limiter. At the same time the auxiliary power supply is activated, powering the main controller and the display. This allows powering up the main SMPS from the switch on the amplifiers front panel.

NOTE: Turning the amplifier off from the user interface (1/0 switch) does not disconnect the amplifier from mains. Disconnecting the amplifier from the mains can only be achieved by physically removing/disconnecting the mains cable. The mains cable therefore has to be freely accessible at all times.

Attention: Never unplug the powerCON® connector while the amplifier is playing music. Always turn the amplifier off from the front panel before disconnecting the powerCON® connector.

Alternatively, you can disconnect the amplifier from the mains via an external all-pole disconnection (e.g. mains breaker).

Disconnect the mains cable during a lightning storm or when the amplifier remains unused or unsupervised for a prolonged period of time. If a power cut occurs while the amplifier is switched on, it will restart automatically once the mains distribution has been restored. All settings prior to the loss of power will be maintained.

For more information regarding the mains protection refer to chapters 4.2 - 4.3 (p. 28).

3.3.2 Inrush current limitation

The LINUS12C has a special processor dedicated to limit the mains inrush current. This limiter will take action under any of the following conditions:

- when connecting the amplifier to the mains through the mains cable
- when switching the amplifier on through an external mains breaker
- the mains voltage was lost for at least 4 half-cycles or more (e.g. a short voltage drop).

This limiter will confine the mains current to a value smaller than $20 A_{rms}^*$.

*Maximum rms value of inrush current over one half-cycle of the mains voltage according to IEC/EN 55032:2016-02 (Electromagnetic compatibility of multimedia equipment - Emission requirements: German version EN 55032:2012/AC:2013).

NOTE: Even under normal conditions the mains current can reach levels up to 32 A/64 A (230 V/115 V) and even higher for very short periods of time. This could cause lamps to flicker if connected to the same mains as the amplifier. The impedance of an AC circuit should be less than 0.157Ω to avoid flicker according to EN 61000-3-11 "Electromagnetic compatibility – Part 3-11: Limits – limitation of voltage changes, voltage fluctuations and flicker in the public low-voltage supply systems – Equipment with rated current $\leq 75 A$ and subject to conditional connection" (IEC 77A/929/CDV:2016).

If in any doubt, consult your local power provider. Never attempt to measure this impedance level with your Ω meter. This may damage your meter and expose you to the risk of electric shock.

3.3.3 Mains power consumption and current draw

Due to the huge output power of the LINUS12C, the mains current draw can get very high when demanding large output powers. Please refer to following table for an overview of mains currents and power consumption under different operating conditions.

Operating condition	Mains current (4 Ω)	Power consumption (4 Ω)	Output power (4 Ω)
Amplifier standby (power off)	0.08 A	17.6 W	0 W
Idle (power on)	0.86 A	191 W	0 W
300 W per channel / 1/8 th	7.27 A	1700 W	1200 W
600 W per channel / 1/4 th	14.54 A	3200 W	2400 W
800 W per channel / 1/3 rd	19.20 A	4350 W	3200 W

Mains current draw and power consumption @ 230 V, 50 Hz.

Measured with pink noise with crest factor of 12 dB to present typical music signal. For 115 V mains operation, the current values can be multiplied by 2.

Please note that the values given here are typical values only, measured on a standard 230 V/50 Hz outlet. The actual mains current draw can vary depending on the music signal and the mains characteristics (especially the mains impedance) of any specific installation.

3.4 Signal inputs

The LINUS12C amplifier offers two different input signal sources:

Analog

In this mode the analog signals connected to the XLR input connectors will be used as input signal.

LiNET

With the LiNET setting the input signals are taken from the LiNET Digital Audio interface.

3.4.1 Analog input

XLR:

Pin 1 = Ground (lifted via 150 resistor to chassis/earth)

Pin 2 = Hot (in polarity, "+")

Pin 3 = Cold (out of polarity, "-")

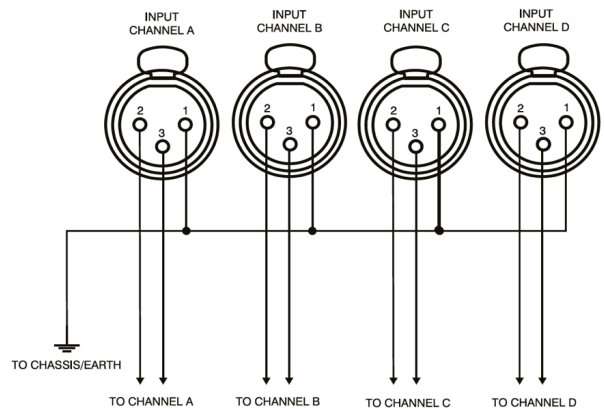

We suggest to always use symmetrically (balanced) shielded cable to connect the amplifier.

3.4.2 LiNET AES/EBU input/output

Eight audio channels are arranged in four AES/EBU pairs. The AES/EBU input and output connectors allow you to receive and send multichannel digital audio streams to other AES/EBU-compatible devices (like other LINUS12C amplifiers for example). Please note that although the AES/EBU and Ethernet connectors use the same connector type (RJ45), the physical transmission protocols are different. So any direct connection between the AES/EBU connectors and standard Ethernet connectors will not work.

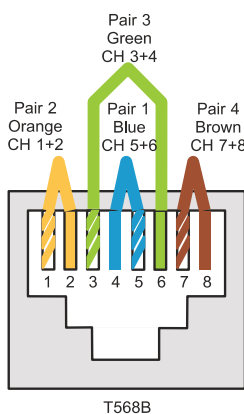

LiNET AES/EBU RJ45 pin wiring

RJ45-Pin	Colour	Channel (polarity)
1	orange-white	1/2 (+)
2	orange	1/2 (-)
3	green-white	3/4 (+)
4	blue	5/6 (+)
5	blue-white	5/6 (-)
6	green	3/4 (-)
7	brown-white	7/8 (+)
8	brown	7/8 (-)

3.5 Remote control inputs (Ethernet)

The Ethernet link network connector allows you to access the LINUS12C from a host computer for remote control, firmware update and downloading DSP presets. Please note that for setting up proper network connection you need to use the CODA Audio LINUS Control software.

3.6 Power outputs

3.6.1 SPEAKON® Connection: SPEAKON® output 1 connector is connected to the channel 1 and 2 amplifier outputs. SPEAKON® output 2 connector is connected to the channel 3 and 4 amplifier outputs. SPEAKON® output 3 connector is connected to the channel 1, 2, 3 and 4 amplifier outputs.

The pin configuration of the SPEAKON® connectors is as follows:

SPEAKON® Output 1	Pin 1 +	Channel 1 amplifier output
	Pin 1 -	Channel 1 inverted
	Pin 2 +	Channel 2 amplifier output
	Pin 2 -	Channel 2 inverted
SPEAKON® Output 2	Pin 1 +	Channel 3 amplifier output
	Pin 1 -	Channel 3 inverted
	Pin 2 +	Channel 4 amplifier output
	Pin 2 -	Channel 4 inverted
SPEAKON® Output 3	Pin 1 +	Channel 1 amplifier output
	Pin 1 -	Channel 1 inverted
	Pin 2 +	Channel 2 amplifier output
	Pin 2 -	Channel 2 inverted
	Pin 3 +	Channel 3 amplifier output
	Pin 3 -	Channel 3 inverted
	Pin 4 +	Channel 4 amplifier output
	Pin 4 -	Channel 4 inverted

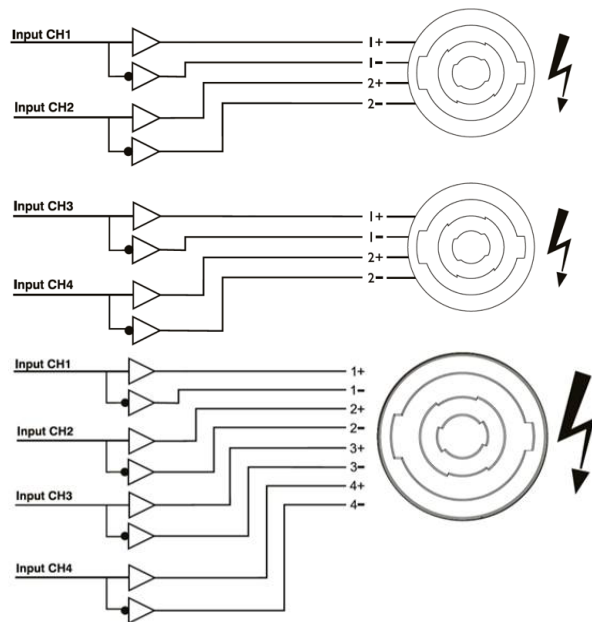

WARNING!

SPEAKON® connector marked with the lightning flashes indicate high voltages that are potentially life threatening. Wiring to these terminals requires installation by an instructed person or the use of ready-made leads or cords. Custom wiring should only be carried out by qualified personnel.

To prevent electric shock, do not operate the amplifier with any of the conductor portion of the speaker wire exposed.

NOTE: For reasons of safety and performance do only use high-quality fully insulated speaker cables of stranded copper wire. Use the largest wire size that is economically and physically practical. Make sure that the cables are not longer than necessary.

4. OPERATION

4.1 Screen user interface

Indication:

1. Channel mute buttons
2. Rotary encoder knob selects, changes and enters parameters
3. Press "ESC" escape button anytime to deny selection and/or go back to main operation page
4. "STORE" snapshots 1-10
5. "UP" skips operation pages up
6. "DOWN" skips operation pages down
7. LiNET LED will indicate, if LiNET signal input signal is selected:
 - LED on → LiNET audio input (clock present)
 - LED off → Analog audio input selected
 - LED flashes constant - - - → No LiNET audio input (clock missing)
 - LED flashes with interval - o → Analog fallback enabled. Analog audio input in use (clock present)
8. Channel selection buttons
9. Input/output signal and protection LEDs
10. Ethernet connection LED

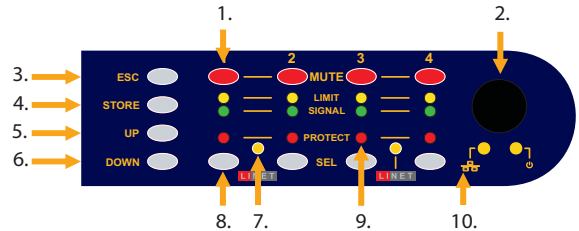

4.1.1 Module number

Move the selection field with the encoder knob to the module number and push to enter selection. Turn encoder knob to select a number from 1 to 250 and press to confirm.

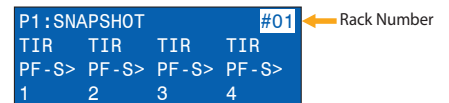

4.1.2. Speaker selection

Move the selection field with the encoder knob to the desired amplifier channel. Press encoder knob to enter speaker series selection.

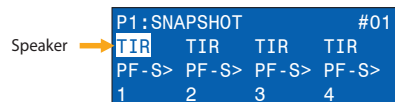

Series selection: ALL, Line Array, APS Series, N-APS Series, HOPS Series, CoRAY Series, G-Series, D-Series, U-Subs, CUE Monitors, Discontinued.

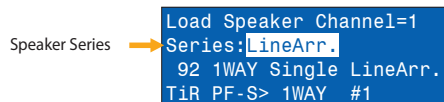

Press encoder knob to enter speaker file selection and move selection field to the next row. Press encoder knob to confirm.

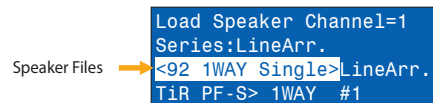

4.1.3 Input signal routing

Move the selection field with the rotary encoder knob to the desired amplifier channel.

Select the input signal type and source (analog or digital):

- Input signal chart - analog inputs: A, B, C, D
- LINET (digital) inputs: 1, 2, 3, 4, 5, 6, 7, 8.

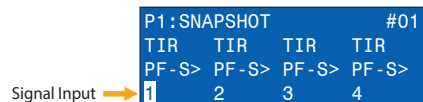

4.1.4 Delay

Press the "DOWN" button to skip to second operation page.
Move selection field to position "D" (DELAY).
Push the encoder knob on the corresponding output channel that you want to delay, then choose its value and confirm.
The delay is shown in ms (milliseconds).

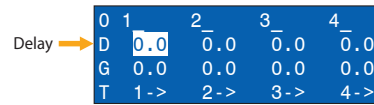

4.1.5 Input gain

Adjust the GAIN (position "G") of the selected channel and push to confirm.

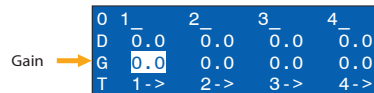

4.1.6 Tuning

Go to position "T" (TUNING) and push the encoder knob to enter tuning page.

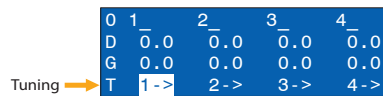

Tuning page

- Array (type in total amount of used line array elements in one hang)
- Sizing
- High Shelf
- Human EQ
- Low Boost
- Sub Sonic

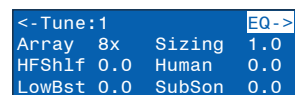
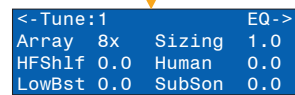

Full parametric EQ

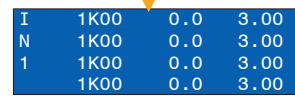

Output Ch Frequency Gain Q Factor

Go to position "EQ" and push the encoder knob to enter FULL PARAMETRIC EQ's page.
Seven parametric EQs are available.

Please refer to LINUS Control operation manual for detailed information about tuning tools.

4.1.7 Device information and display settings

Press the "DOWN" button twice (in the main page).

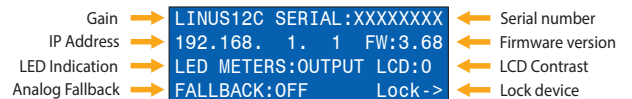

4.1.8 Analog fallback

ANALOG FALLBACK can be activated as redundant analog signal for LiNET signal source.

Select "INPUT" on the main page. Numbers indicate LiNET and letters indicate analog fallback signal source.

Signal hierarchy:

- (1) LiNET
- (2) Analog

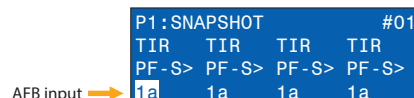
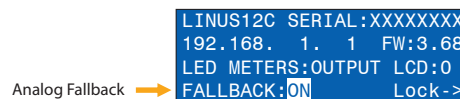

AFB input

LiNET LED indication:

- LED on → LiNET audio input (clock present)
- LED flashes constantly (slow) --- → No LiNET audio input (clock missing)
- LED flashes with interval (fast) - o → Analog fallback enabled. Analog audio input in use (clock present).

Display indication:

If there is no clock present, the unit will switch automatically to the selected analog signal source. Indicated with capital letter and four stars (per channel).

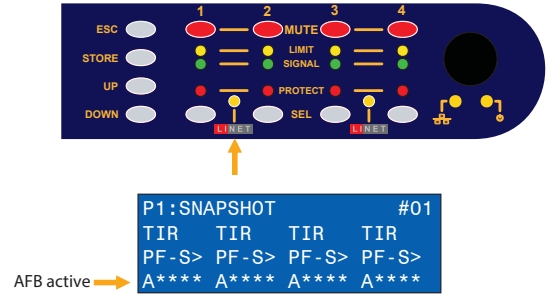

RECOVER FALLBACK:

If clock is present, the LED will flash fast, LiNET source can be recovered by pressing CH buttons 1+2.

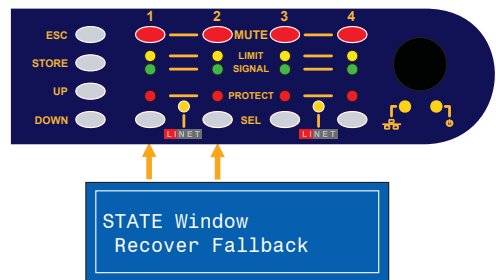

4.1.9 Lock device

Navigate to the device overview page and select the "LOCK" function.

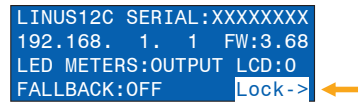

Define your new password (in numbers) and confirm.

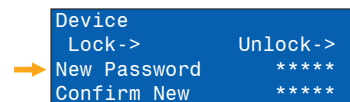

After the definition of password add it into the "CURRENT PASSWORD" field and press "LOCK".

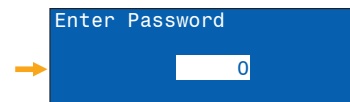

Device can be unlocked by entering the pre-defined password into the "ENTER PASSWORD" field.



Press "UNLOCK" to unlock the device.

4.1.10 Quick lock device

You can "QUICK LOCK" your device anytime. Press "STORE" and the 1st channel "SELECTION" button (the same for unlock).

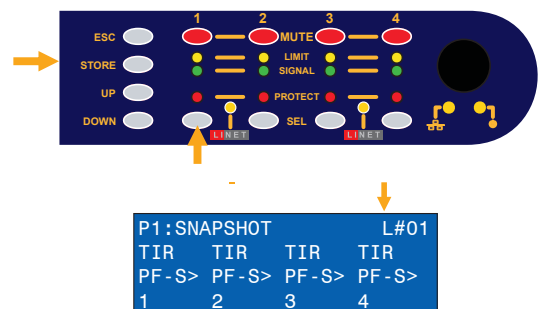

Display will switch automatically to the main configuration page and it will indicate the lock of the device with the capital letter "L".

4.1.11 Store snapshot

Store your customised user settings (inclusive tuning parameters) in the library positions (01) to (10) of the unit.

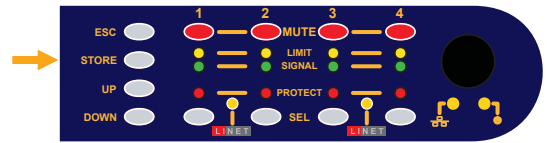

```
Store Snapshot
Store to - S01 -
Cancel > Store >
```

SNAPSHOT NAME:
Use encoder knob to navigate to the name field and press it.

Snapshot name field →

```
Store Snapshot
Store to -S01-
Snapshot
Cancel > Store >
```

Text position cursors are channel selection buttons
1= << and 2= >> digit selection via encoder knob.

```
Store Snapsho[XYZ_ -012]
Store to -S01-
Snapshot 1
F1=cursor<< F2=cursor>>
```

Press encoder knob to confirm.

Use encoder knob to navigate to the store field and press it.

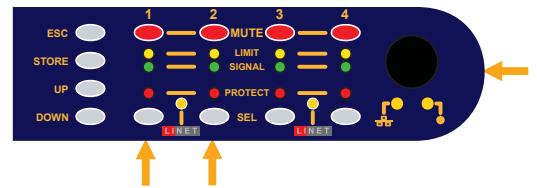

```
Store Snapshot
Store to -S01-
Snapshot 1
Cancel > Sttore >
```

Defined "SNAPSHOT" is displayed now in the snapshot library. It includes all the defined speaker, signal routing and tuning parameters.

```
P1:SNAPSHOT 1 #01
TIR TIR TIR TIR
PF-S> PF-S> PF-S> PF-S>
1 2 3 4
```

4.2 Power amp protection

4.2.1 DC protection

Each output of the power amp is constantly monitored for persistent DC voltage levels. If the 10 V threshold voltage is exceeded at any of the outputs, the SMPS will be automatically switched off to prevent further damage from overload to the power amplifier and speakers. In this case, the system restarts and tries to readjust the DC parameters. If this does not succeed after the third run, it switches to a permanent error. A DC issue can be located in the output stage, the driver stage, or at the input of the amplifier.

4.3 Mains protection

4.3.1 Inrush current limitation

Within one second of the LINUS12C amplifiers being connected to the mains, the inrush current limiter will charge the primary capacitors in a controlled way, limiting the maximum mains current during startup.

4.3.2 Mains overvoltage detection

There is a overvoltage protection in the mains input. If the mains input voltage exceeds 270 V, the main power supply remains switched off and a high, loud buzzing tone sounds from the device as a warning.

4.4 Main SMPS protection

4.4.1 Overcurrent protection

The main SMPS (Switched Mode Power Supply) transformer current of your LINUS12C amplifier is continuously monitored. If overcurrent occurs, the main SMPS immediately stops working. Should there be an internal failure, this feature prevents other parts from being damaged.

4.4.2 Overload protection

The output stage is permanently monitored for possible overload situations. There are varying limiting levels of the look-forward overload protection depending on connected output load. These limits will be set automatically from a load measurement on each output channel. This improves reliability without degrading sound quality when driving complex loads. In case of extremely high output levels with heavily clipped output signals and low loudspeaker impedances $< 2.5 \Omega$, this additional protection will reduce the amplifier stage output power very quickly. If activated, this indicates that the amplifier is running close to its absolute maximum power capacity and the limit LEDs on the front panel are flashing. In normal operation (no clipping or only slight clipping) this protection should never be activated.

4.4.3 Thermal protection

The temperature of the main SMPS transformer of your LINUS12C amplifier is permanently monitored. If the temperature exceeds 70° C/158° F, a thermo limiter will act on the total system power and avoid a SMPS shutdown.

4.5 Fans

The fans mounted in your LINUS12C amplifier operate permanently, but as long as the temperature remains below 40°C /104°F, they will run at their slowest speed. The highest detected temperature from the heatsinks of each channel and SMPS transformer controls the speed of the fans. Above 40°C/104°F the speed is increased until it reaches its maximum value.

5. SPECIFICATION

General

Number of output channels	4
Output stage	Class D-IC
Internal samplerate / bit-depth	96 kHz/24 bit
Signal-to-noise ratio (22 Hz - 20 kHz, 4 Ω - analog input)	> 108 dB (unweighted) > 111 dB (A-weighted)
Signal-to-noise ratio (22 Hz - 20 kHz, 4 Ω - digital input)	> 116 dB (unweighted) > 119 dB (A-weighted)
Frequency response (8 Ω load with CLEAR preset)	20 Hz – 20 kHz = (+0.0 dB/-1.0 dB)
THD+N & IMD (4 Ω load @ 1/2 output power)	20 Hz – 20 kHz = < 0.005%
Latency (input to loudspeaker output)	Minimum 2.70 ms AES/EBU input Minimum 2.00 ms analog input
Protection circuits	Inrush current limiter Thermal limiter Output DC SMPS over-current Output overload
LED indicators	Mute status Limit Signal Protection Ethernet control active Digital signal locked Power on
Ethernet connection	2 x 100 Mbps RJ45 Control

AC Mains

AC mains input connector	Neutrik 32 A powerCON®
AC mains voltage (high range)** (dual voltage SMPS with automatic voltage range selection)	180 V = Minimum 230 V = Nominal 265 V = Maximum
AC mains voltage (low range)** (dual-voltage SMPS with automatic voltage range selection)	90 V = Minimum 115 V = Nominal 132 V = Maximum
AC mains frequency	47 – 63 Hz
Power consumption* (¼ power = 600 W @ 4Ω to represent typical music signal)	Amplifier in standby = 17.6 W Amplifier idle = 191 W Amplifier ¼ power = 3200 W

Input

Input sources	Analog & AES/EBU
Analog input impedance (balanced)	12 kΩ
Maximum input level (analog differential)	+18 dBu/6.15 Vrms
Input connections	4 x XLR3 Analog IN 1 x RJ45 LINET IN (8 x CH) 1 x RJ45 LINET LINK (8 x CH) 1 x RJ45 AUX
Supported digital input formats (Internal SRC)	32 kHz / 44.1 kHz / 48 kHz / 88.2 kHz / 96 kHz / 176.4 kHz / 192 kHz

Output

RMS output power* (20 Hz - 20 kHz, THD < 0.01%) (all channels driven)	1600 W @ 8 Ω 3000 W @ 4 Ω 4000 W @ 2.7 Ω 4100 W @ 2 Ω
Peak output power* (20 Hz - 20 kHz) (all channels driven)	3200 W pk @ 8 Ω 6000 W pk @ 4 Ω 5500 W pk @ 2.7 Ω 4800 W pk @ 2 Ω
Maximum output voltage*	+/- 155 V pk
Maximum output current*	+/- 52 A pk
Damping factor (8 Ω load, 1 kHz and below)	2500
Minimum output load	2 Ω nom
Power output connections	2 x Neutrik NL4 speakON® 1 x Neutrik NL8 speakON®

Thermal

Operating temperature	+5° C to +55° C 41° F to 131° F
Thermal output (BTU/h)	679.02 = Idle 2124 = 20% 4437 = 50% 8287 = 100%
Thermal output (kWh)	0.199 = Idle 0.623 = 20% 1.300 = 50% 2.429 = 100%
Cooling	2 x thermally controlled fans. Hot air expelled at rear.

Physical

Dimensions (W x H x D)	483.5 x 88 x 454.18 mm 19" x 3.46" x 17.88" (2 Rack units)
Shipping dimensions (W x H x D)	675 x 130 x 560 mm 26.57" x 5.12" x 22.05" Volume = 0.049 m³ 1.73 ft³
Net weight	14.70 kg 32.4 lbs
Shipping weight	17.5 kg 38.6 lbs

* Typical values – some variation may exist due to component tolerances.

** Voltage range should not be exceeded. Amplifier output power performance will degrade below nominal voltage and increase above nominal voltage.

6. PERFORMANCE

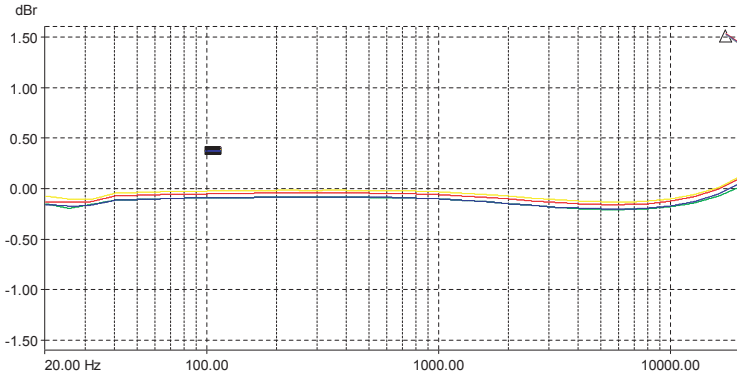

Figure 6.1
Gain vs. frequency w/AES17-filter
@ 120 W output power,
4 Ω (measurement of a typical performance)

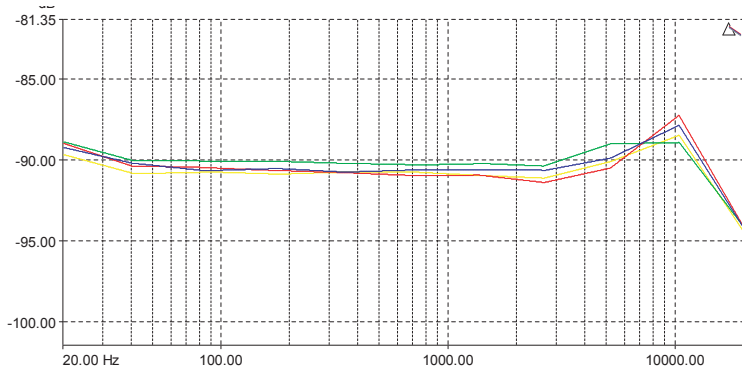

Figure 6.2
THD+N w/AES17-filter @ 20 Hz --> 20 kHz, 120 W
output power, 4 Ω
(measurement of a typical performance)

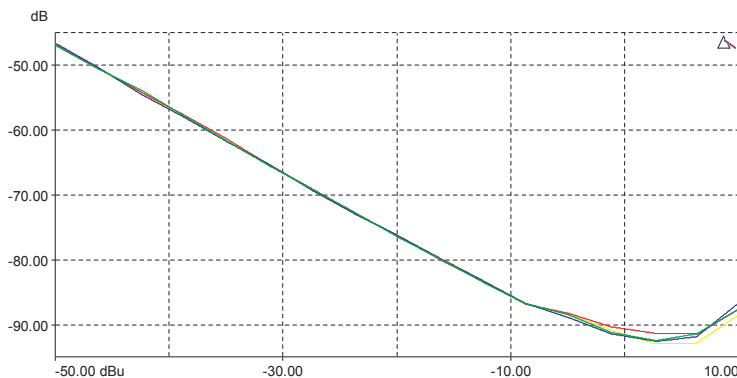

Figure 6.3
THD+N w/AES17-filter @ -50 dBu --> +10 dBu, 4 Ω
(measurement of a typical performance)

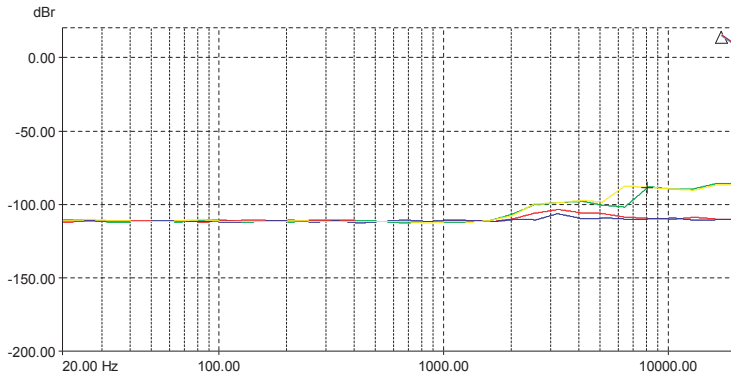

Figure 6.4
Channel separation OR crosstalk
@ 20 Hz --> 20 kHz
(measurement of a typical performance)

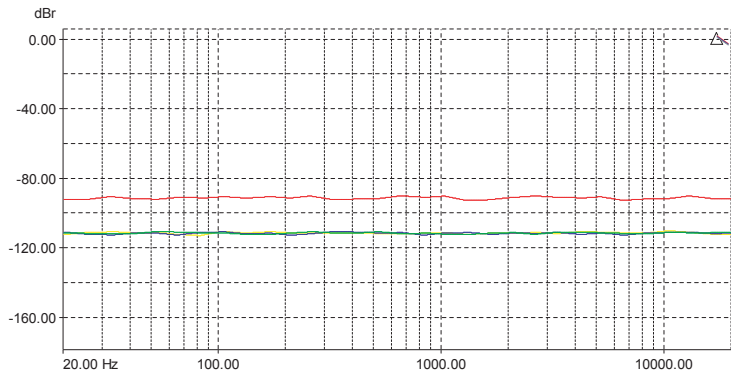

Figure 6.5
Common mode rejection
@ 20 Hz --> 20 kHz
(measurement of a typical performance)

7. WARRANTY

7.1 Warranty

CODA Audio guarantees the LINUS12C amplifier to be free from defective material and/or workmanship for a period of five (5) years from the date of sale. When a defect occurs under normal installation and use, CODA Audio will repair the product under this warranty. In this event, please return the amplifier to your dealer/distributor together with a copy of your sales receipt as proof of purchase.

This warranty provides that examination of the returned product must indicate in our judgement a manufacturing defect.

7.2 Items excluded from this warranty

CODA Audio is not liable for any damage caused by shipping accidents, misuse, abuse, operation with incorrect AC voltage, operation with faulty peripheral equipment, modification or alteration without prior factory approval, service by an unauthorized service centre and normal wear and tear. Amplifiers on which the serial number has been removed or defaced are not eligible for warranty service.

7.3 What CODA Audio will do

CODA Audio (or its appointed agent) undertakes to rectify any defect regardless of the reason for failure (unless excluded from this warranty), by repair, replacement or refund as it sees fit.

7.4 How to obtain warranty service

You must notify your dealer/distributor of your need for warranty service. All components must be shipped in the original packaging.

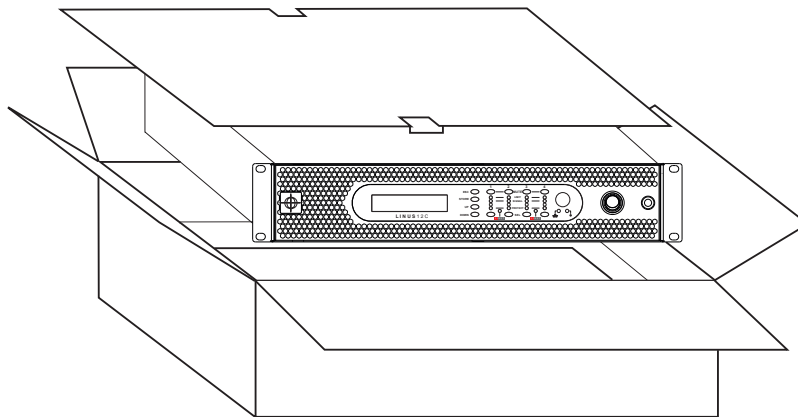

7.5 CODA Audio's product improvement

CODA Audio reserves the right to improve the technical standard of its products without giving prior notice. If in any doubt, please consult your dealer/distributor or contact CODA Audio directly for clarification. We are always working on making CODA products even better and accessible all over the world. Please check our website for the latest list of approvals and certificates.



LINUS12C 7. WARRANTY

7.6 Warranty form

PLEASE ENCLOSE THIS COMPLETED FORM WITH THE AMPLIFIER, DO NOT SEND IT SEPARATELY!

Owner's information

Company name: _____

Contact: _____

Address: _____

Telephone: _____

Fax: _____

Email address: _____

Model: _____

Serial number: _____

Purchase date: _____

Expired warranty/If the warranty has expired, payment will be: Cash / Cheque / VISA / MasterCard

Shipping address: _____

To transport the amplifier, the original packing materials must be used. Please return the amplifier to the following address or your nearest CODA Audio appointed distributor.

Nature of problem occurred. Please describe the conditions that existed when the problem occurred and what attempts were made to correct it:

Other equipment in your system:

Our website: www.codaaudio.com provides a complete list of licensed CODA Audio dealers/distributors.

8. MAINTENANCE INFORMATION

Cleaning and servicing work on the inside of the amplifier must only be carried out by qualified personnel.

Qualified personnel is defined as a person who has gained specialised relevant knowledge of electronic engineering through education, training, and experience, and who has sufficient knowledge of all relevant governmental work safety regulations to be in a position to judge the safe functioning of power amplifiers based on technical rules according to IEC/ EN 62368-1:2018 ("Safety Requirements for Audio, Video or similar Electronic Appliances").

In order to guarantee the safe functioning of the amplifier, it has to be checked regularly, depending on its application but at least once a year, by a properly qualified person.

Advice on how to carry out these checks can be found in DIN VDE 0701-0702:2008-06 "Safety Checks for Electronic Appliances". An amplifier that is considered to be unsafe must be labelled accordingly and stored in a safe place to prevent this amplifier being used mistakenly.

9. DECOMMISSIONING

During the decommissioning process of the amplifier, all legally prescribed rules and procedures must be adhered to.

10. WHAT'S IN THE BOX

Shipped with Schuko to powerCON® 32 A, 1 m cable. US amplifier 120VAC ships with 2 m NEMA L5-30P to powerCON 32 A.

